

Pfaff 437 706 81

Pfaff 437 706 83

Pfaff 437 706 02

Pfaff 437 706 04

Subclass



PFAFF[®] **437-706/81**
-706/83

437-706/02*
-706/04*

CSMP

Unterklassen-Ausstattung

Subclass parts

Composition des sous-classes

Composición de las subclases

Unterklassen-Ausstattung¹⁾

Équipement des sous-classes¹⁾

Subclass organization¹⁾

Dotación de las subclases¹⁾

Unterklasse Subclass Sous-classe Subclase	Ausführung Model Version Tipo de máquina	Überstichbreite in mm Stitch width in mm Jetée de l'aiguille en mm Anchura de zigzag en mm	Nadelstange Needle bar Barre à aiguille Barra de aguja	Stoffschieber ⁴⁾ Feed dog Griffe Transportador inferior	Stichplatte ⁴⁾ Needle plate Plaque à aiguille Placa de aguja	Nähfuß ⁴⁾ Presser foot Pied presseur Pie prensatejas
-3/83*	BN 2,5	3,0	91-168 019-91	91-059 237-04	91-158 232-04	91-157 377-91
	B ^{30/0}	2,0	91-168 019-91	91-059 601-04	91-158 329-04	91-157 377-91
-6/41*	AN 24 ^{30/0}	4,5	91-168 019-91	91-047 690-04	91-058 213-04	91-055 376-03
	BN 24	6,0	91-168 019-91	91-047 687-04	91-058 212-04	91-055 373-03
	B ^{30/0}	4,5	91-168 019-91	91-047 701-04	91-058 282-04	91-055 376-03
		6,0	91-168 019-91	91-047 685-04	91-058 256-04	91-055 373-03
-6/61*	A; B	4,5	91-168 019-91	91-047 701-04	91-058 282-04	91-055 509-93
		6,0	91-168 019-91	91-047 685-04	91-058 256-04	91-055 512-93
17/81*	B	4,5	91-168 019-91	91-494 148-04	91-494 149-04	91-494 150-04
-32/03*	BN 24	4,5	91-168 019-91	91-047 576-04	91-058 114-04 ^{11/2}	91-057 368-93
		6,0	91-168 019-91	91-047 575-04	91-058 113-04	91-057 699-93
	B ^{30/0}	4,5	91-168 019-91	91-047 344-04	91-058 035-04 ^{11/2}	91-057 368-93
		6,0	91-168 019-91	91-047 343-04	91-058 034-04	91-057 699-93
-32/04*	BN 24	4,5	91-168 019-91	91-047 576-04	91-058 114-04 ^{11/2}	91-055 882-91
		6,0	91-168 019-91	91-047 575-04	91-058 113-04	91-055 885-91
	B ^{30/0}	4,5	91-168 019-91	91-047 344-04	91-058 035-04 ^{11/2}	91-055 882-91
		6,0	91-168 019-91	91-047 343-04	91-058 034-04	91-055 885-91
-32/05	BN 24	6,0	91-168 019-91	91-047 575-04	91-058 113-04	91-055 987-03
-32/23*	BN 24	4,5	91-168 019-91	91-047 576-04	91-058 114-04 ^{11/2}	91-057 368-93
		6,0	91-168 019-91	91-047 575-04	91-058 113-04	91-057 699-93
-39/81*	BN 2,5	6,0	91-168 019-91	91-047 868-04	91-058 580-04	91-494 150-04
-61/04*	BN 24	4,5	91-168 019-91	91-047 576-04	91-058 114-04 ^{11/2}	91-057 368-93
-155/99*	B	6,0	91-168 019-91	91-047 344-04	91-058 035-04 ^{11/2}	91-494 150-04
-305/02*	BN 2,5	4,5	91-168 019-91	91-047 576-04	91-058 114-04 ^{11/2}	91-057 970-03

¹⁾ Die Liste enthält nur Nähwerkzeuge und Apparate. Beim Umbau in eine andere Unterklasse oder Ausführung sind auch noch Maschinenteile erforderlich. Geben Sie also bei Bestellungen die genaue Bezeichnung der vorhandenen und der gewünschten Ausführung bekannt.

¹⁾ This list contains sewing parts and attachments only. When converting to another subclass or version, machine parts are also necessary. Therefore when ordering please indicate exactly the existing version and the one required.

¹⁾ Cette liste ne contient que les organes de couture et les guides. En cas de transformation en une sous-classe ou variante différente, il faut utiliser aussi certaines pièces de machine supplémentaires. En cas de commande, prière de toujours indiquer par conséquent les variantes disponibles et souhaitées.

¹⁾ Esta lista sólo contiene elementos de costura y aparatos. Siempre que haya que transformar la máquina en otro tipo o subclase, se necesitarán también piezas de máquina, por lo que deberá indicarse en los pedidos el tipo exacto de que se dispone y el deseado.

⁴⁾ = Ausführung angeben
= Indicate model
= Préciser la version

⁵⁾ = Nähmuster einsenden
= Submit sewing sample
= Joindre échantillons de couture

^{11/2} = Überstichbreite bei Bestellung angeben
= Indicate max. stitch width on order
= Indiquer jetée d'aiguille à la commande

^{30/0} = nicht mehr im Programm;
jedoch Ersatzteile lieferbar
= No longer part of production range;
substitute available
= Raye du programme, pièces détachées
toutefois livrables
= Fuera de programa; las piezas de recambio,

Equipement des sous-classes¹⁾
 Unterklassen-Ausstattung¹⁾

Dotación de las subclases¹⁾
 Subclass organization¹⁾

Unterklasse Subclass Sous-classe Subclasse	Ausführung Model Version Tipo de máquina	Stiftschleuß Vibating presser foot Pied enlaineur Transportador superior	Apparat Attachment Appareil Aparato	Linesal Edge guide Guide droit Guia recta	Träger Bracket Support Soporte	Bandtrommel Tape reel Tambour-dérouleur Tambor portacintas
-3/83*	BN 2,5	91-049 335-45				
	B <u>300</u>	91-049 352-45				
-6/41*	AN 24 <u>300</u>	91-049 622-45				
	BN 24	91-049 623-45				
	B <u>300</u>	91-049 622-45				
		91-049 623-45				
-6/61*	A, B	91-049 155-45				
		91-049 155-45				
17/81*	B	91-049 155-45	91-056 106-23		91-056 109-25	91-056 116-90
-32/03*	BN 24	91-049 256-45				
		91-049 281-45				
	B <u>300</u>	91-049 256-45				
		91-049 281-45				
-32/04*	BN 24	91-049 227-45				
		91-049 228-45				
	B <u>300</u>	91-049 227-45				
		91-049 228-45				
-32/05	BN 24	91-049 659-45		91-056 655-25	91-753 936-90	
		91-049 256-45		91-050 946-23	91-753 936-90	
-32/23*	BN 24	91-049 281-45		91-050 946-23	91-753 936-90	
-39/81*	BN 2,5	91-049 155-45	91-053 674-23		91-056 109-25	91-056 116-90
-61/04*	BN 24	91-049 256-45		91-056 655-25	91-753 936-90	91-056 758-91
-155/99*	B	91-049 155-45	99-116 082-25		91-753 936-90	
-305/02*	BN 2,5	91-049 295-45	91-056 730-23		91-753 936-90	

Unterklasse kann mit Faden-
 durchzieh- und -abschneidein-
 richtung -900/51; /75 geliefert
 werden; dabei bleiben die aufge-
 führten Bestellnummern unver-
 ändert.

Bei Maschinen mit -706/83
 ändert sich die Bestellnummer
 der Nadelstange von
 91-168 019-91 in
 91-167 720-91

*) Subclass can be supplied with
 thread puller/trimmer
 -900/51; /75; in this case the
 ordering numbers listed remain
 unchanged.

On machines with subclass
 -706/83 the part number for
 the needle bar is changed from
 91-168 019-91 to
 91-167 720-91

*) Sous-classe livrable avec
 coupe-fil -900/51; /75; les
 numéros de commande restent
 inchangés.

En cas de machines équipées
 de la ss-cl. -706/83 le numéro
 de cde de la barre à aiguille
 91-168 019-91 est remplacé
 par 91-167 720-91

*) La subclase se puede su-
 strar con el cortahilos aut
 co -900/51; /75; perman
 invariables los números c
 pedido indicados.

En el caso de máquinas
 -706/83, el N° de pedid
 barra de aguja 91-168 C
 se cambia por el
 91-167 720-91

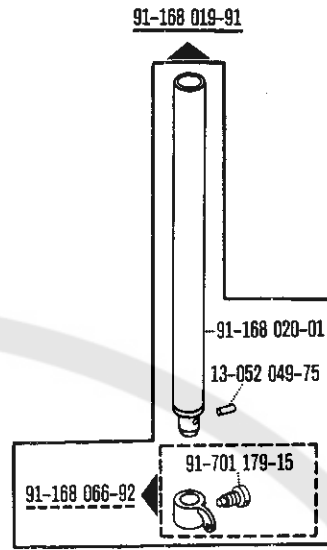
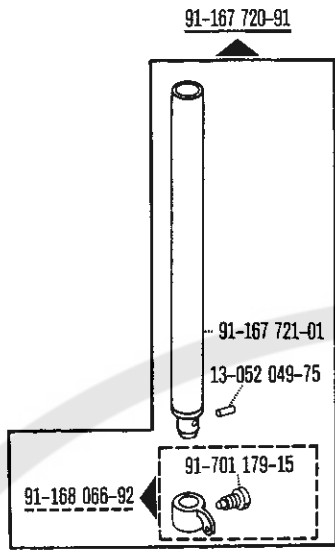
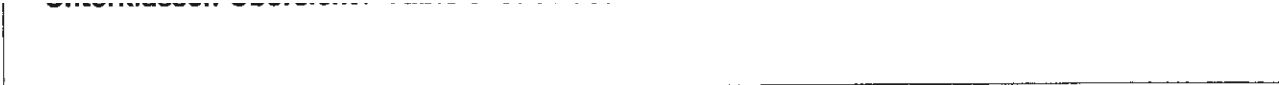

-706/83 (-706/04)

-706/81 (-706/02)

91-047 343-04

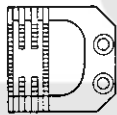

-32/03
-32/04

91-047 344-04

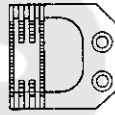

-32/03
-32/04
-155/99

91-047 575-04

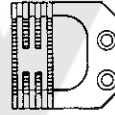

-32/03
-32/04
-32/05
-32/23

91-047 576-04

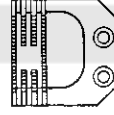

-32/03
-32/04
-32/23
-61/04
-305/02

91-047 685-04

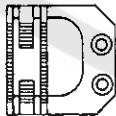

-6/41
-6/61

91-047 687-04

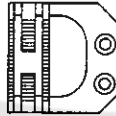

-6/41

91-047 690-04

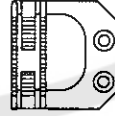

-6/41

91-047 701-04

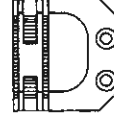

-6/41
-6/61

91-047 868-04

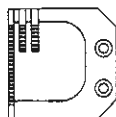

-39/81

91-059 237-04

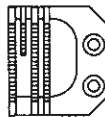

-3/83

91-059 601-04

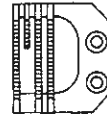





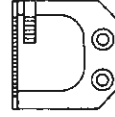





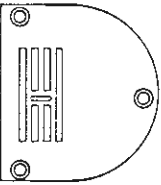

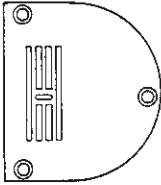

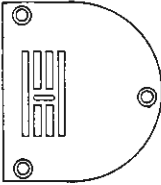

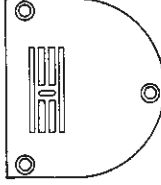

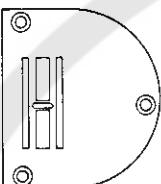

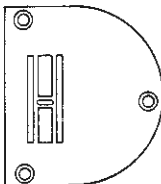

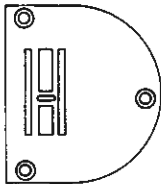

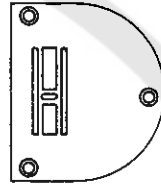

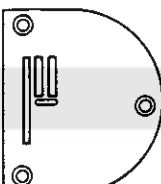

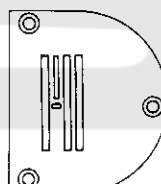

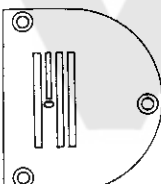

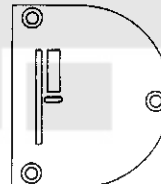

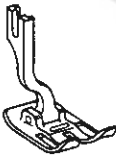
-3/83

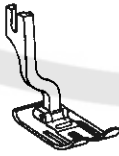
91-494 148-04



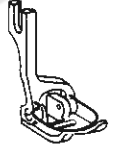
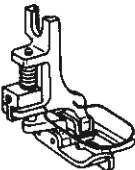
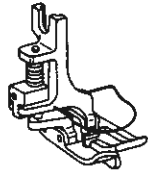



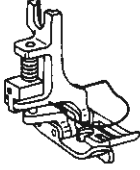



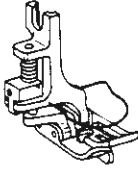

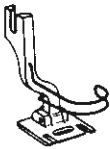
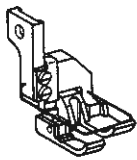

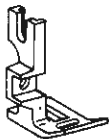



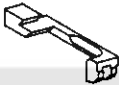

-17/81

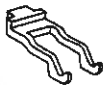
Unterklassen-Übersicht / Table of subclasses / Table des sous-classes / Tabla de subclasses

<p>91-058 034-04 </p>  <p>-32/03 -32/04</p>	<p>91-058 035-04  </p>  <p>-32/03 -32/04 -155/99</p>	<p>91-058 113-04 </p>  <p>-32/03 -32/04 -32/05 -32/23</p>	<p>91-058 114-04  </p>  <p>-32/03 -32/04 -32/23 -61/04 -305/02</p>
<p>91-058 212-04 </p>  <p>-6/41</p>	<p>91-058 213-04 </p>  <p>-6/41</p>	<p>91-058 256-04 </p>  <p>-6/41 -6/61</p>	<p>91-058 282-04 </p>  <p>-6/41 -6/61</p>
<p>91-058 580-04 </p>  <p>-39/81</p>	<p>91-158 232-04 </p>  <p>-3/83</p>	<p>91-158 329-04 </p>  <p>-3/83</p>	<p>91-494 149-04 </p>  <p>-17/81</p>
<p>91-055 373-03 </p>  <p>-6/41</p>	<p>91-055 376-03 </p>  <p>-6/41</p>	<p>91-055 509-93 </p>  <p>-6/61</p>	<p>91-055 512-93 </p>  <p>-6/61</p>
<p>91-055 882-91</p> 	<p>91-055 885-91</p> 	<p>91-055 887-03 </p> 	<p>91-057 368-93 </p>  <p>-32/03 -32/23</p>

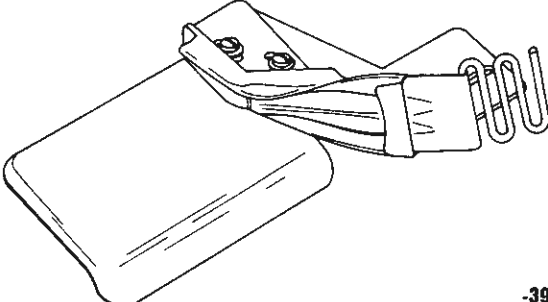
Unterwasser-Operation / TABLE OF SUBSTITUTES / TABLE DES EQUIVALENTS / TABLE DE SUBSTITUCES

<p>91-057 699-93 </p>  <p>-32/03 -32/23</p>	<p>91-057 970-03 </p>  <p>-305/02</p>	<p>91-157 377-91</p>  <p>-3/83</p>	<p>91-494 150-04  </p>  <p>-17/81 -39/81 -155/99</p>
	<p>91-049 155-45</p>  <p>-6/61 -17/81 -39/81 -155/99</p>	<p>91-049 227-45</p>  <p>-32/04</p>	<p>91-049 228-45</p>  <p>-32/04</p>
<p>91-049 256-45</p>  <p>-32/03 -32/23 -61/04</p>	<p>91-049 281-45</p>  <p>-32/03 -32/23</p>	<p>91-049 295-45</p>  <p>-305/02</p>	<p>91-049 335-45</p>  <p>-3/83</p>
<p>91-049 352-45</p>  <p>-3/83</p>	<p>91-049 622-45</p>  <p>-6/41</p>	<p>91-049 623-45</p>  <p>-6/41</p>	<p>91-049 659-45</p>  <p>-32/05</p>
<p>91-053 674-23 </p>  <p>-39/81</p>		<p>11-108 168-15</p> <p>12-305 114-15 </p>  <p>-17/81</p>	

Unterklassen-Übersicht / Table of subclasses / Table des sous-classes / Tabla de subclasses

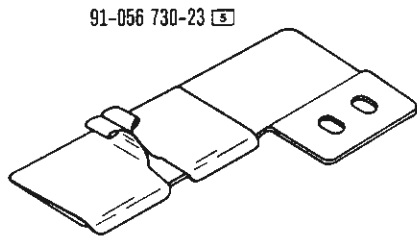

91-056 730-23

-305/02

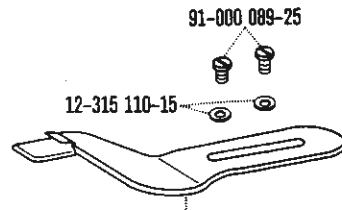

91-000 089-25

12-315 110-15

91-050 946-23

-32/23

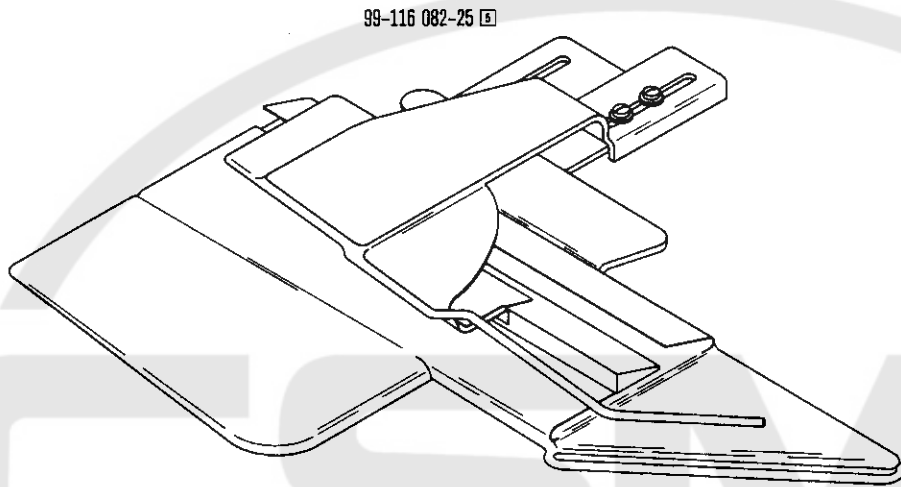

99-116 082-25

-155/99

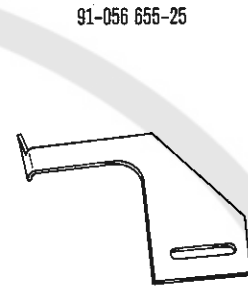

91-056 655-25

-32/05
-61/04

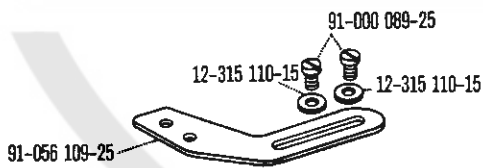

91-000 089-25

12-315 110-15

12-315 110-15

91-056 109-25

-17/81
-39/81

91-753 936-90

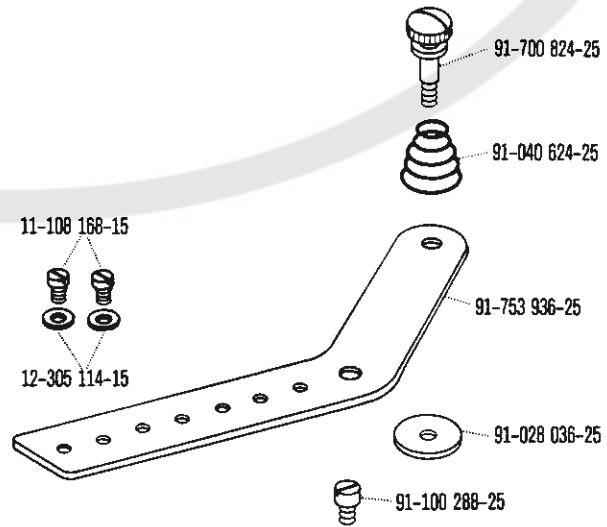

91-700 824-25

91-040 624-25

11-100 168-15

91-753 936-25

12-305 114-15

91-028 036-25

91-100 288-25

-32/03
-32/05
-61/04
-155/99
-305/02

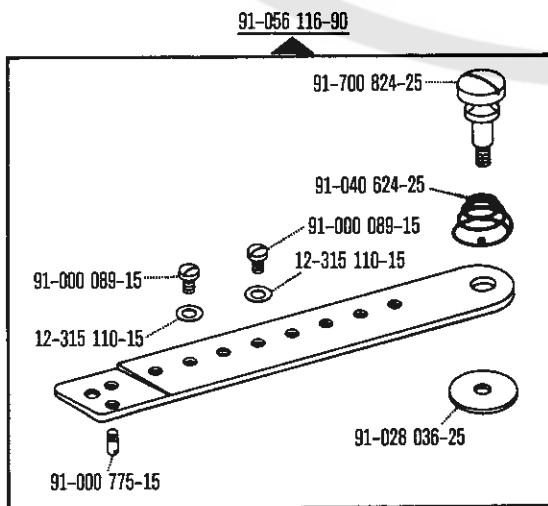

91-056 116-90

91-700 824-25

91-040 624-25

91-000 089-15

91-000 089-15

12-315 110-15

12-315 110-15

91-028 036-25

91-000 775-15

-17/81
-39/81

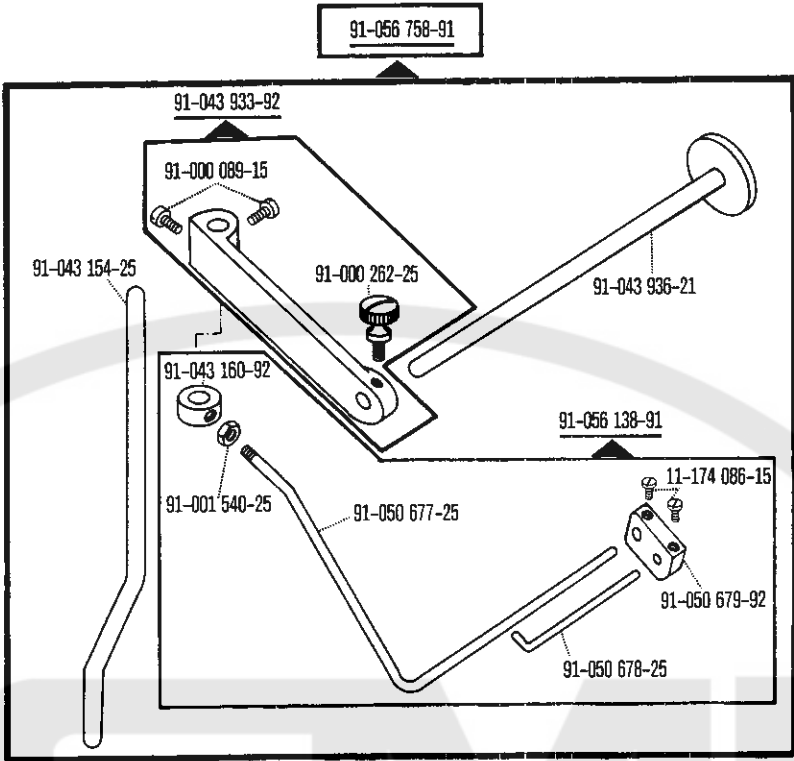

-61/04

Pfaff, D 6750 Kaiserslautern, Postfach 3020/3040, Telefon (0631) 200-0, Telex: 45753, Telefax (0631) 17202